

MS8250A/B

Digital Multimeter

Operation Manual

1. Safety information



Warning

Please particularly note that inappropriate use may cause shock or damage to the meter. When using, comply with common safety procedures and completely follow the safety measures stated in the operation manual.

In order to make full use of the meter's functions and ensure safety operation, please carefully read and follow the use methods in the operation manual.

The meter meets GB/T 13978-92 digital multimeter general technology conditions, GB4793.1-1995 (IEC 61010-1, IEC 61010-2-032) electronic measurement instrument safety requirements with secondary pollution and over-voltage standard of CAT IV 600V.

Please follow the safety operation guidelines to ensure the safe use of meter.

The meter will provide satisfactory service to you if you use and protect it appropriately.

1.1 Preparation

1.1.1 When using the meter, the user should comply with standard safety rules:

- General shock protection
- Prevent misusing the meter

1.1.2 Please check for damage that may have occurred during transportation after receiving the meter.

1.1.3 If it should be stored and shipped under hard conditions, please confirm if the meter is damaged.

1.1.4 Probe should be in good condition. Before use, please check whether the probe insulation is damaged and whether metal wire is bare (not properly insulated).

1.1.5 Use the probe table provided with the meter to ensure safety. If necessary, it should be replaced with another identical probe or one with the same capacity.- 1 -

Safety information

1.2 Usage

- 1.2.1 When using, select the correct function and measuring range.
- 1.2.2 Don't exceed the indicated maximum of each measuring range.
- 1.2.3 When measuring circuits with the meter connected, do not touch the probe tip (metal part).
- 1.2.4 When measuring, if the voltage to be measured is more than 60 V DC or 30 V AC (RMS), always keep your fingers always behind finger protection device.
- 1.2.5 Don't measure voltage greater than 600 V.
- 1.2.6 For manual measuring range, when the value to be measured is unknown, select, the highest measuring range.
- 1.2.7 Before rotating conversion switch to change measuring function, remove probe from the circuit to be measured.
- 1.2.8 Don't measure resistors, capacitors, diodes and circuit connections with power.
- 1.2.9 During tests of current, resistors, capacitors, diodes and circuit connections, avoid connecting the meter with voltage sources.
- 1.2.10 Do not measure capacitance before capacitor is discharged completely.
- 1.2.11 Do not use the meter in explosive gas, vapor or dusty environments.
- 1.2.12 If you find any abnormal phenomena or failure on the meter, stop using it immediately.
- 1.2.13 Do not use the meter unless the bottom case and the battery cover are completely fastened in their original places.
- 1.2.14 Don't store or use the meter in direct sunlight or high temperature and high humidity conditions.

1.3 Mark



Note (Important safety information. Refer to the operation manual)



Can be used for dangerous electric conductor.

Double insulation protection (class II)

CAT IV According to pulse voltage tolerance protection level provided by IEC 61010-1 standard overvoltage (installation) level III and pollution degree 2.

Safety information



The meter complies with EU standard



Grounding

1.4 Maintenance

- 1.4.1 Don't try to open the meter bottom case to adjust or repair. Such operations only can be operated by technicians who fully understand the meter and electrical shock hazard.
- 1.4.2 Before opening the meter bottom case or battery cover, it should remove probe from the circuit to be measured.
- 1.4.3 To avoid incorrect readings and possibly causing electric shock, when "⚡" appears on the meter display, replace the battery immediately.
- 1.4.4 Clean the meter with damp cloth and mild detergent. Do not use abrasives or solvents.
- 1.4.5 When the meter is not used, switch the measuring range to OFF position.
- 1.4.6 If the meter is not used for long time, remove the battery to prevent damage to the meter.

Description

2. Description

- The meter is a portable, professional measuring instrument with LCD display and back light for easy reading by users. Measuring range switch is operated by one hand for ease of operation. The meter has overload protection and low battery indicator. It is an ideal multifunction meter no matter for professionals, factories, schools, fans or family use.
- The meter is used to measure AC current, DC current, voltage, DC voltage, frequency, duty ratio, resistance, capacitance measurement and circuit connection, diode test.
- The meter has automatic measuring range and manual measuring range.
- The meter's AC current and AC voltage are measured with True RMS.

The meter has:

- reading hold function.
- relative measuring function.
- max. measuring function.
- min. measuring function.
- auto power off function.
- When measuring AC voltage and AC current, the meter can measure frequency of AC voltage and AC current synchronously.

2.1 Part name

- (2) Non-contact voltage detection indicator
- (3) LCD display
- (4) Key
- (5) Functional rotary switch

Description

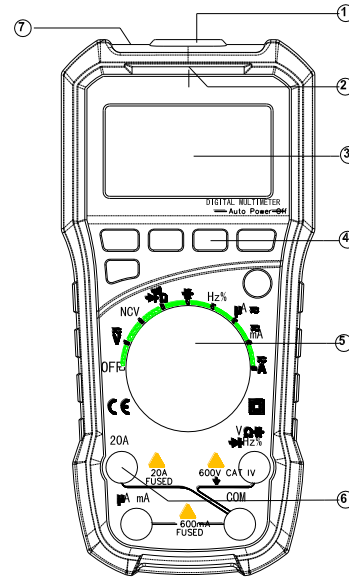

Description

(6) Input socket

(7) Non-contact voltage induction area

2.2 Switch, button and input jack description

HOLD key: used for reading hold.

FUNC key: used for measuring function switch.

RANGE key: used for switching automatic measuring range or manual measuring range.

REL key: used for switching relative to measuring function.

Hz% key: used for duty ratio and frequency measurement function switch.

 Backlight key: turn on backlight

OFF position: used for shutting off the power.

 Jack: voltage, resistance, frequency, duty ratio, capacitance, diode, circuit connection input wire connecting terminal.

COM Jack: common wire connecting terminal

μA mA Jack: μA and mA current input terminal.

20A Jack: 20A current input terminal.

2.3 LCD display

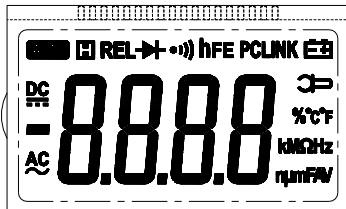

Description

 AC

 DC

 Diode

 Audible continuity

AUTO Automatic measuring range mode

MAX Maximum measurement state

MIN Minimum measurement state

 Low battery

% Percentage (duty ratio)

Hz, kHz Hertz, Kilohertz (frequency)

mV, V Millivolt, Volt (voltage)

μA, mA, A Ampere (current)

nF, μF, mF Microfarad, Millifarad (capacitance)

Ω, kΩ, MΩ Ohm, Kilohm, Megohm (resistance)

REL Relative measurement mode

Description**3. Specifications**

The meter should be recalibrated annually. When calibrating, temperature should be 18°C~28°C, and relative humidity should be less than 75%.

3.1 General

3.1.1 Automatic measuring range and manual measuring range

3.1.2 Full measuring range overload protection

3.1.3 The maximum allowable voltage between measurement end and ground: 600V DC or AC (RMS)

3.1.4 Operational height: maximum 2000 m

3.1.5 Display: LCD

3.1.6 Displayed maximum value: digit 3999

3.1.7 Polarity indication: automatical indication, '-' means negative polarity.

3.1.8 Exceeding measuring range display: '0L' or '-0L'

3.1.9 Sampling time: digital display is about 0.4 sec/time, analog display 0.04 sec/time (except current measurement). When measuring current, digital display is about 1 sec/cycle, analog display 0.1 sec/cycle.

3.1.10 Unit display: has function and power unit display.

3.1.11 Auto off time: 30 sec

3.1.12 Operating power supply: 9V, 6F22 battery.

3.1.13 Battery low voltage indication: LCD displays  symbol.

3.1.14 Temperature coefficient: less than 0.1×accuracy/°C

3.1.15 Operating temperature: 0°C ~ 40°C

3.1.16 Storage temperature: -10°C ~ 50°C

3.1.17 Dimension: 180×86×52mm

3.1.18 Weight: about 250 g (not including battery)

Description**3.2 Technical indicators**

Environment temperature: 23±5°C, relative humidity (RH): <75%

3.2.1 DC voltage

Measuring range	Resolution	Accuracy
400mV	0.1mV	±(0.8% reading + 3 digits)
4.0V	0.001V	±(0.5% reading + 5 digits)
40V	0.01V	
400V	0.1V	
600V	1V	

- Input impedance: 10M Ω

- Overload protection: 400mV measuring range: 250V DC or AC (RMS), 4.0V-600V measuring range:

600V DC or 600V AC (RMS))

- Maximum input voltage: 600V DC

Specification**3.2.3 AC voltage**

Measuring range	Resolution	Accuracy
400mV	0.1mV	$\pm(1\% \text{ reading} + 5 \text{ digits})$
4V	0.001V	$\pm(0.8\% \text{ reading} + 5 \text{ digits})$
40V	0.01V	
400V	0.1V	
600V	1V	$\pm(1.2\% \text{ reading} + 3 \text{ digits})$

- Input impedance: 10M Ω
- Maximum input voltage: 600V AC (RMS)
- Frequency range: 50 ~ 60Hz
- Response: true RMS

3.2.4 Resistance

Measuring range	Resolution	Accuracy
400 Ω	0.1 Ω	$\pm(1\% \text{ reading} + 5 \text{ digits})$
4k Ω	0.001k Ω	
40k Ω	0.01k Ω	
400k Ω	0.1k Ω	
4M Ω	0.001Mk Ω	
10M Ω	0.1M Ω	$\pm(1.2\% \text{ reading} + 15 \text{ digits})$

- Open circuit voltage: about 0.4V
- Overload protection: 250V DC or AC (RMS)

Specification**3.2.5 Capacitance**

Measuring range	Resolution	Accuracy
40nF	0.01nF	$\pm(3.0\% \text{ reading} + 5 \text{ digits})$
400nF	0.1nF	
4 μ F	0.01 μ F	
40 μ F	0.01 μ F	
100 μ F	0.1 μ F	

- Overload protection: 250V DC or AC (RMS)

3.2.6 Diode test

Measuring range	Resolution	Function
	0.001V	Display approximate diode forward voltage value

- Forward DC current is about 1mA
- Backward DC voltage is about 3.3V
- Overload protection: 250V DC or AC (RMS)

3.2.7 Circuit continuity test

Measuring range	Resolution	Function
	0. 1 Ω	If the resistance of circuit to be measured is less than 50 Ω , the meter's built-in buzzer will sound.

- Open circuit voltage is about 1.2V
- Overload protection: 250V DC or AC (RMS)

Specification**3.2.8 Frequency****3.2.8.2 Pass Hz grade:**

Measuring range	Resolution	Accuracy
5Hz	0.01Hz	±(0.5% reading + 2 digits)
50Hz	0.1Hz	
500Hz	0.001kHz	
5kHz	0.01kHz	
50kHz	0.1kHz	
500kHz	1kHz	
5MHz	10kHz	

Overload protection: 250V DC or AC (RMS) - measurement signal: Vpp3V
AC signal

3.2.8.3 Duty ratio

Measuring range	Resolution	Accuracy
10 - 95%	0.1%	± 2.0%

Specification**3.2.9 DC current**

Measuring range	Resolution	Accuracy
400μA	0.1μA	±(0.8% reading + 2 digits)
4000μA	1μA	
40mA	10μA	
400mA	100μA	
20A	10mA	±(1.2% reading + 2 digits)

Overload protection:

μA and mA grade: Fuse F400mA/250V, A grade: Fuse F20A/250V.

When measuring current is greater than 5A, the continuous measurement time should not be more than 10 seconds. After measuring, disconnect the current.

3.2.10 AC current

Measuring range	Resolution	Accuracy
400μA	0.1μA	±(1.5% reading + 2 digits)
4000μA	1μA	
40mA	10μA	
400mA	100μA	
20A	10mA	±(3.0% reading + 5 digits)

Overload protection:

μA and mA grade: Fuse F600mA/250V, A grade: Fuse F20A/250V.

- Frequency range: 50 ~ 60Hz

- Response: true RMS

When measuring current is greater than 5A, the continuous measurement time should not be more than 10 seconds. After measuring, disconnect the current.

Specification

4. Operating guidance

4.1 Reading hold

- 4.1.1 In the process of measurement, if reading hold is required, press “**HOLD**” key, the value on the display will be locked.
- 4.1.2 Press “**HOLD**” key again to cancel reading hold.

4.2 Measuring range switch

- 4.2.1 When turning the conversion switch to current, voltage, resistance, capacitance, frequency grade, the meter is in automatic measuring range mode.
- 4.2.2 Press “**RANGE**” key, the meter will enter the manual range mode. Ppress once, the measuring range will go up with one grade. If it is pressed at the highest measuring range, it will go to the minimum measuring range.
- 4.2.3 If the user presses “**RANGE**” key more than 1 sec, the meter will restore automatic measuring range.

Note:

Frequency and capacitance measurement can't be set to manual measuring range mode.

4.3 Relative measurement mode switch

4.3.1 Press “**REL**” key to enter the relative measurement mode. When making relative measurement, the measurement value at the moment of pressing REL key in the internal memory of the meter is called initial value. The display value after that is the current measurement value - initial value.

4.4 Duty ratio and frequency measurement choice

- 4.4.1 Press “**Hz%**” key at Hz grade. The meter will enter the duty ratio measurement state. Press “**Hz%**” key again. The meter will enter frequency measurement state.

Operating guidance

4.5 Function switch

- 4.5.1 When measuring voltage and current, press “**FUNC**” key to switch AC voltage and AC current.
- 4.5.2. When measuring voltage and current, press “**FUNC**” to switch different measuring signals.

4.6 Backlight

- 4.6.1 Press “” key to open the backlight, the backlight will automatically turn off after 20 seconds.

4.7 Automatic power-off

- 4.7.1 If there is no operation for 30 minutes after turning the machine on, the meter will automatically power off to save the battery.
- 4.7.2 After automatic power-off, press any key to turn the meter on again.
- 4.7.3 Holding the “**FUNC**” key when powering on will cancel automatic power-off function.

4.9 NCV (non-contact voltage detection)

- 4.9.1 Turn the meter to NCV grade
- 4.9.2 Place the meter top close to the conductor. When test voltage is greater than 110 Vac (RMS), the meter induction voltage indicator will turn on and buzzer will give dripping alarm sound.

Note: 1: Even there is no indication, voltage may still exist. Don't use non-contact voltage detector to judge whether there is voltage in the wire. Detection operation could be affected by socket design, insulation thickness, type and other factors.

- 2: When inputting voltage on the meter input terminal, due to the existence of the induced voltage, voltage induction indicator also may light.
- 3: Interference sources in the external environment (such as flashlight, motor, etc.) may trigger erroneous non-contact voltage detection.

4.10 AC voltage/DC voltage measurement

Voltage is the potential difference between two points. AC voltage polarity changes over time, while DC voltage polarity does not change over time.

DC voltage measuring range of this meter: 400.0mV, 4.000V, 40.00V, 400.0V, 600V; AC voltage measuring range of this meter: 400.0mV, 4.000V, 40.00V, 400.0V, 600V. The 400mV measuring range can be entered only in the manual measuring range mode.

To measure AC and DC voltage:

- 4.10.1 Rotate switch to voltage position.
- 4.10.2 Respectively connect black and red test probes to COM input socket and V input socket.
- 4.10.3 Measure the voltage of circuit to be tested with other two ends of test probes. (Connected with the circuit to be tested in parallel)
- 4.10.4 Read the measuring voltage value from LCD display. When measuring DC voltage, the display will simultaneously show the voltage polarity which is connected with red test probe.
- 4.10.5 Press FUNC key to switch AC voltage, DC voltage measurement.

4.11 Ω Measurement

Resistance range of this meter: 400.0 Ω , 4.000k Ω , 40.00k Ω , 400k Ω , 4.000M Ω , 10.00M Ω .

To measure resistance:

- 4.11.1 Rotate rotary switch to  position.
- 4.11.2 Respectively connect black and red test probes to COM input socket and V input socket.
- 4.11.3 Measure the resistance value of circuit to be tested with other two ends of test probes.
- 4.11.4 Read the measuring resistance value from LCD display.

4.12 Measurement

When measuring resistance, press FUNC key to switch continuity test.

- 4.12.1 Respectively connect black and red test probes to COM input socket and Ω input socket.
- 4.12.2. Measure the resistance value of circuit to be tested with other two ends of test probes
- 4.12.3. During continuity test, if the measured circuit resistance is not greater than about 50 Ω , the buzzer may issue continuous sound.

4.13 Measurement

When measuring continuity, press FUNC key to switch to diode test.

- 4.13.1 Respectively connect black and red test probes to COM input socket and Ω input socket.
- 4.13.2. Measure two ends of diode to be measured with other two ends of test probes
- 4.13.3. The meter will display the forward voltage drop value of the diode.

4.14 Capacitance measurement

Capacitance range of this meter: 40.00nF, 400.0nF, 4.000 μ F, 40.00 μ F, 100.0 μ F

To measure capacitance:

4.14.1 Rotate rotary switch to  position.

4.14.2 Respectively connect black and red test probe to COM input socket and  input socket.

4.14.3 Measure the capacitance value of circuit to be tested with other two ends of test probes and read the measuring value from LCD display.

4.15 Frequency and duty ratio measurement

Capacitance range of this meter: 5Hz, 50Hz, 500Hz, 5kHz, 50kHz, 5MHz

To measure capacitance:

4.15.1 Rotate the switch to Hz position.

4.15.2 Respectively connect black and red test probe to COM input socket and Hz input socket.

4.15.3 Measure the frequency to be measured with other two ends of test probes and read the measuring value from LCD display.

4.16 Current measurement

Current range of this meter: 400 μ A, 4000 μ A, 40.00mA, 400.0mA, 10.000A;

4.16.1 Cut off the power supply of circuit to be tested. Discharge all high voltage capacitors on the circuit to be tested.

4.16.2 Rotate switch to the appropriate position (μ A, mA or A grade).

4.16.3 Connect the black test probe to the COM input socket. If the current to be tested is lower than 600mA, connect the red test probe to the mA input socket; if the measured current is between the range of 600mA~10A, the red test probe should be connected to 20A input socket.

4.16.4 Cut off the circuit to be tested. Connect the black test probe to one end of disconnected circuit (low voltage relatively), and connect the red test probe to the other end of disconnected circuit (high voltage relatively).

4.16.5. Connect the power supply of circuit to be tested, then read the display reading. If the display shows only “OL”, the input is out of the selected input range, so please rotate the switch to a higher measuring range.

4.17 Communicate with computer (only for MS8250B)

One end of USB cable is connected to one end of the meter, the other end is connected to computer USB interface, at this time, the meter will display PCLINK, open the special software of this machine to read and save the meter measuring data.

5. Maintenance

5.1 Replace battery

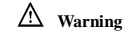

Before opening the meter battery cover, remove probe from the circuit to be measured to avoid electric shock.

5.1.1 When the battery indicator “” appears, the battery should be replaced immediately.

5.1.2 Unscrew the fastening screw of the meter battery cover and remove it .

5.1.3 Replace battery.

5.1.4 Install the battery cover.

Note:

The battery polarity can't be reversed.

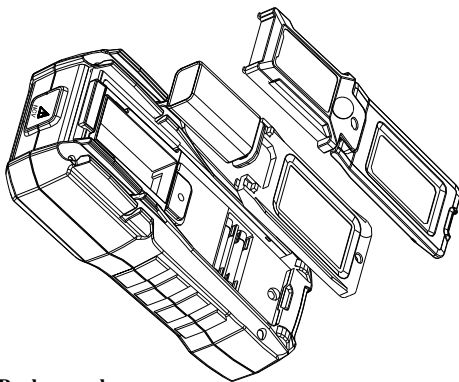
Attachments**5.2 Replace probe****Warning**

When replacing probe, replace with another identical probe or one with the same capacity. The probe should be in good condition, with a capacity of 1000V, 10A.

If the probe is damaged, such as having a bare metal wire, it should be replaced immediately.

6. Accessories

1)	Probe		1 pc
2)	Operation Manual		1 pc
3)	Battery	9V 6F22	1 pc
4)	Interface cable	USB interface cable (MS8250B)	1 pc
5)	CD	Communication software CD (MS8250B)	1 pc

Dongguan Huayi Mastech Co., Ltd

Shenzhen Huayi Mastech Co., Ltd

Address: Floor 9, Block 3 West, Saige Science & Technology Park, North Huaqiang Road, Shenzhen City

Tel.: 0755-83766634 0755-83766670

Fax.: 0755-83766510

Post Code: 518028

E-mail: info@mastech.cn

Website: www.mastech.cn